

COMO IEC/UL

Load break switches
from 30 to 63 A

2017

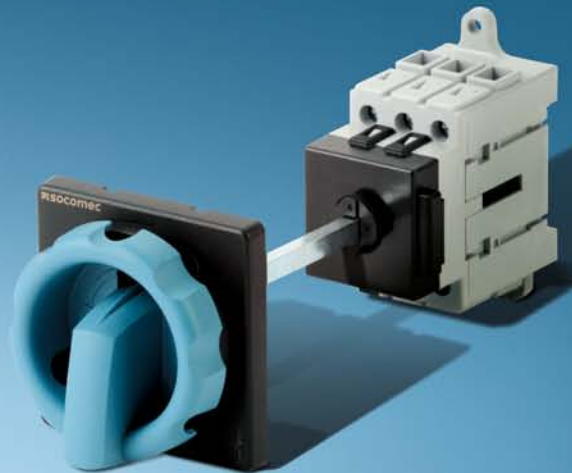

your energy
our expertise





COMO

Load break switches
from 30 to 63 A



Function

COMO are compact and modular load break switches. They make and break under all types of load conditions and provide safe isolation for any low voltage circuit, especially for machine control circuits.

General characteristics

- 2 stable positions (I, 0)
- Double break per phase
- Positive contact indication
- Contact point technology
- Padlocking in 0 position
- IP20 devices and accessories

Advantages

Easy mounting

Three mounting possibilities are available for optimum integration and time saving:

- DIN rail or back plate mounting,
- Door mounting,
- "Quick Fix" mounting to save time when integrating in high quantities.

Compact

Thanks to its compact design panel space is greatly reduced.

Safety

- Direct access to connection terminals for adequate tightening
- Lockable rotary operating mechanism

The solution for

- > Industrial control systems



Strong points

- > Easy mounting
- > Compact
- > Safety

Conformity to standards

- > IEC 60947-3



- > UL 60947-4-1⁽¹⁾



⁽¹⁾ New UL standard replaces UL508

Local safety enclosures

- > The COMO is fitted within a polycarbonate enclosure and can be used, for example, for on load breaking of a motor (HP rated).

References

DIN rail/back plate mounting

Rating (A)		Type	Switch	4 th pole	External handle K1 type IP65 - 4/4X blue/black no defeater	External handle K1 type IP65 - 4/4X red/yellow no defeater	Extension shaft	Aux contact NO+NC	Neutral pole	Earth pole	Terminal shrouds
IEC	UL										
32 A	30 A	for direct operation	2111 3003	2111 1003	-	-	-	2113 4000	2111 1056	2111 1076	1 P (top and bottom) 2113 5001 3 P (top and bottom) 2113 5003
		for external operation	2111 3103		with guide shaft 2113 1112	with guide shaft 2113 1113	200 mm 2113 2200				
				with cross coupling 2113 1212	with cross coupling 2113 1213	320 mm 2113 2320					
63 A	50 A	for direct operation	2111 3005	2111 1005	-	-	-				
		for external operation	2111 3105		with guide shaft 2113 1112	with guide shaft 2113 1113	200 mm 2113 2200				
				with cross coupling 2113 1212	with cross coupling 2113 1213	320 mm 2113 2320					

Door mounting

Rating (A)		Type	Switch	4 th pole	External handle K1 type IP65 - 4/4X blue/black no defeater	External handle K1 type IP65 red/yellow no defeater	Aux contact NO+NC	Neutral pole	Earth pole	Terminal shrouds
IEC	UL									
32 A	30 A	with screws	2111 3203	2111 1203	2113 1322	2113 1323	2113 4200	2111 1256	2111 1276	1 P (top and bottom) 2113 5001 3 P (top and bottom) 2113 5003
		quick fix	2111 3303		2113 1332	2113 1333				
63 A	50 A	with screws	2111 3205	2111 1205	2113 1322	2113 1323				
		quick fix	2111 3305		2113 1332	2113 1333				

Accessories

External operation handle

DIN-rail or back plate mounting

Rating (A)		Handle type	With guide shaft or cross coupling	Handle colour	External IP ⁽¹⁾	Nema degree of protection	Reference
IEC	UL						
32 ... 63	30 ... 50	K1	guide shaft	black/blue	IP65	4, 4X	2113 1112
				red/yellow			2113 1113
			compensation	black/blue			2113 1212
				red/yellow			2113 1213

(1) IP: Degree of protection according to standard IEC 60529.



Door mounting

Rating (A)		Handle type	Door mounting type	Handle colour	External IP ⁽¹⁾	Nema degree of protection	Reference
IEC	UL						
32 ... 63	30 ... 50	K1	4 screws	black/blue	IP65	4, 4X	2113 1322
				red/yellow			2113 1323
			quick fix	black/blue			2113 1332
				red/yellow			2113 1333

(1) IP: Degree of protection according to standard IEC 60529.



Shaft for external handle

Use

Shaft extensions are for external front operation. The shaft is clipped directly into the COMO without using a screw.

Shafts

7.9 in (200 mm), 12.6 in (320 mm), (custom length, for high qty).

Rating (A)		Handle type	Length		Reference
IEC	UL		(in)	(mm)	
32 ... 63	30 ... 50	K1	7.9	200	2113 2200
			12.6	320	2113 2320



Additional pole

Use

Installation of this switched pole converts a 3 pole COMO into a 4 pole load break switches, 3 pole + neutral or 3 pole + earth.

The 4th pole can be mounted without tools on the right or left side of the device.

Max 2 additional modules, 1 switching module and 1 unswitched module.

Switched fourth pole module

Rating (A)		Type of mounting	Type	Reference
IEC	UL			
32	30	back mounting	switched	2111 1003
		door mounting		2111 1203
63	50	back mounting		2111 1005
		door mounting		2111 1205



Solid neutral pole

Rating (A)		Type of mounting	Type	Reference
IEC	UL			
32 ... 63	30 ... 50	back mounting	unswitched	2111 1056
		door mounting		2111 1256

Ground module

Rating (A)		Type of mounting	Type	Reference
IEC	UL			
32 ... 63	30 ... 50	back mounting	unswitched	2111 1076
		door mounting		2111 1276

Auxiliary contacts

Use

There are two types of auxiliary contact, one for back plate mounting and one for door mounting. NO+NC auxiliary contacts per device (1 on each side of the device).

Rating (A)		Type of mounting	Contact(s)	Contact type	Reference
IEC	UL				
32 ... 63	30 ... 50	back mounting	1 contact	NO+NC	2113 4000
		door mounting			2113 4200



Terminal shrouds

Use

Top and bottom protection against direct contact with terminal or connection parts.

Available in 1 or 3 pole version. Top and bottom pair.

Rating (A)		Type of mounting	No. of poles	Position	Pack (unit)	Reference
IEC	UL					
32 ... 63	30 ... 50	back/door mounting	1 P	top and bottom	2	2113 5001
			3 P			2113 5003

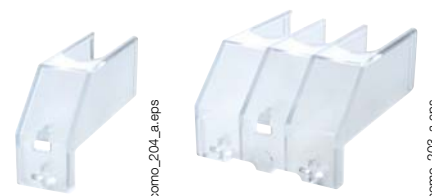

Characteristics

Characteristics according to IEC 60947-3

Rated current I _n	32 A	63 A
Thermal current at 40°C (A)	32	63
Thermal current at 50°C (A)	32	63
Thermal current at 60°C (A)	26	50
Rated insulation voltage U _i (V)	690	690
Rated impulse withstand voltage U _{imp} (kV)	6	6
Operational power in AC-23A (kW)		
400 VAC without pre-break AC	11.5	22
Operational power in AC-3 (kW)		
400 VAC without pre-break AC	9.5	18.5
Fuse protected Power in AC3 (kW)		
Prospective short-circuit current (kA rms)	6	6
Associated fuse rating (A)	32	63
Short-circuit capacity (without protection)		
Rated short-time withstand current I _{cw} 1s (A rms)	640	1000
Connection		
Minimum Cu cable cross-section (mm ²)	2	2
Maximum Cu cable cross-section (mm ²)	16	16
Maximum tightening torque (Nm)	3	3
Mechanical characteristics		
Durability (number of operating cycles)	100 000	100 000
Operating torque (Nm)	1.27	1.27

Characteristics according to UL 60947-4-1 (replaces UL508)

General use rating (A)	30 A	50 A
Short circuit rating at 600 VAC (kA)		5
Branch circuit fuse type		RK5
Max fuse rating (A)		50
Max horsepower rating / Max motor FLA current		
120 VAC / 1 phase	2 / 24	3 / 34
120 VAC / 3 phase	3 / 19.2	5 / 30.4
240 VAC / 1 phase	3 / 17	10 / 50
240 VAC / 3 phase	10 / 28	10 / 28
480 VAC / 3 phase	20 / 27	25 / 34
600 VAC / 3 phase	22 / 27	30 / 32
Connection terminals		
Solid - 1 wire (AWG)		#14 - #6
Solid - 2 wires (AWG)		2 x (#14 - #6)
Auxiliary contacts		
Electrical characteristics		A300
Mechanical characteristics		
Durability (number of operating cycles)		100 000
Operating torque (lbs.in / Nm)		11.24 / 1.27

Dimensions (in/mm)

Back mounting

Direct operation

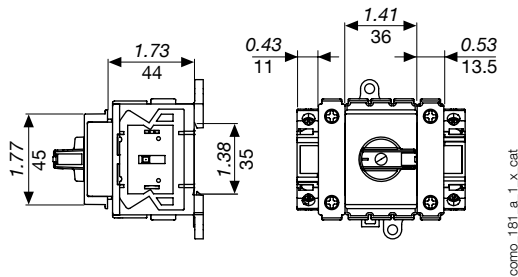

External operation

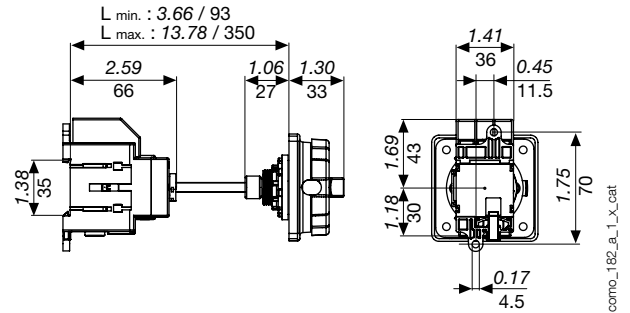

Door mounting

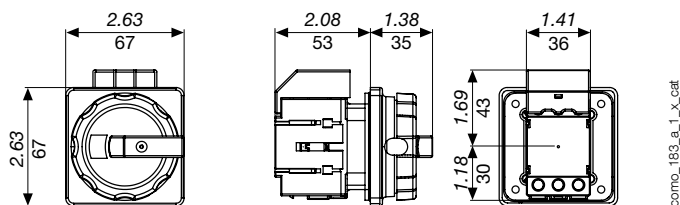

Door mounting quick fix

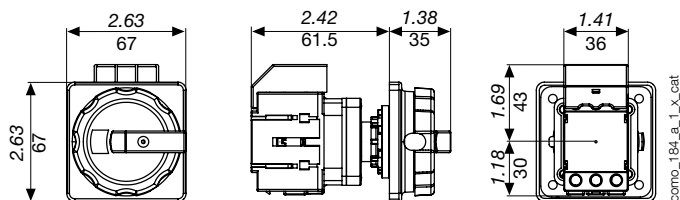

External handles dimensions (in/mm)

K1 type

Standard handle

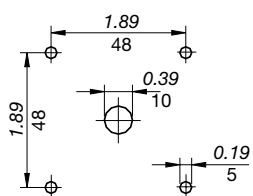

Quick fix handle

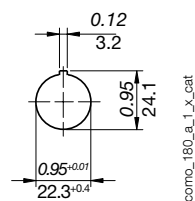

Socomec worldwide

IN EUROPE

BELGIUM

Critical Power / Power Control & Safety / Energy Efficiency

Tel. +32 2 340 02 30
Fax +32 2 346 28 99
info.be@socomec.com

FRANCE

Critical Power / Power Control & Safety / Energy Efficiency

Tel. +33 1 45 14 63 00
Fax +33 1 48 67 31 12
dcm.ups.fr@socomec.com

GERMANY

Critical Power

Tel. +49 621 71 68 40
Fax +49 621 71 68 444
info.ups.de@socomec.com

Power Control & Safety / Energy Efficiency

Tel. +49 7243 65292 0
Fax +49 7243 65292 13
info.scp.de@socomec.com

ITALY

Critical Power

Tel. +39 02 98 242 942
Fax +39 02 98 240 723
info.ups.it@socomec.com

Power Control & Safety / Energy Efficiency

Tel. +39 02 98 49 821
Fax +39 02 98 24 33 10
info.scp.it@socomec.com

NETHERLANDS

Critical Power / Power Control & Safety / Energy Efficiency

Tel. +31 30 760 0900
Fax +31 30 637 2166
info.nl@socomec.com

POLAND

Critical Power

Tel. +48 22 825 73 60
Fax. +48 22 825 73 70
info.ups.pl@socomec.com

Power Control & Safety / Energy Efficiency

Tel. +48 91 442 64 11
Fax +48 91 442 64 19
info.scp.pl@socomec.com

PORTUGAL

Critical Power / Power Control & Safety / Energy Efficiency

Tel. +351 261 812 599
Fax +351 261 812 570
info.ups.pt@socomec.com

ROMANIA

Critical Power / Power Control & Safety / Energy Efficiency

Tel. +40 21 319 36 88
Fax +40 21 319 36 89
info.ro@socomec.com

SERBIA

Critical Power / Power Control & Safety / Energy Efficiency

Tel. +381 11 40 43 246
Fax +381 11 40 43 245
info.rs@socomec.com

SLOVENIA

Critical Power / Power Control & Safety / Energy Efficiency

Tel. +386 1 5807 860
Fax +386 1 561 11 73
info.si@socomec.com

SPAIN

Critical Power / Power Control & Safety / Energy Efficiency

Tel. +34 93 540 75 75
Fax +34 93 540 75 76
info.es@socomec.com

SWITZERLAND

Critical Power

Tel. +41 44 745 40 80
Fax +41 44 745 40 85
info@socomec.ch

TURKEY

Critical Power / Power Control & Safety / Energy Efficiency

Tel. +90 216 540 71 20-21-22
Fax +90 216 540 71 27
info.tr@socomec.com

UNITED KINGDOM

Critical Power

Tel. +44 1285 863 300
Fax +44 1285 862 304
info.uk@socomec.com

Power Control & Safety / Energy Efficiency

Tel. +44 1462 440 033
Fax +44 1462 431 143
info.uk@socomec.com

IN ASIA PACIFIC

AUSTRALIA

Critical Power / Power Control & Safety / Energy Efficiency

Tel. +61 2 9325 3900
Fax +61 2 9888 9544
info.ups.au@socomec.com

CHINA

Critical Power / Power Control & Safety / Energy Efficiency

Tel. +86 21 52 98 95 55
Fax +86 21 62 28 34 68
info.cn@socomec.com

INDIA

Critical Power / Power Control & Safety / Energy Efficiency

Tel. +91 44 39215400
Fax +91 44 39215450 & 51
info.in@socomec.com

SINGAPORE

Critical Power / Power Control & Safety / Energy Efficiency

Tel. +65 6506 7600
Fax +65 64 58 7377
info.sg@socomec.com

THAILAND

Critical Power

Tel. +66 2 941 1644 7
Fax +66 2 941 1650
info.ups.th@socomec.com

IN MIDDLE EAST

UNITED ARAB EMIRATES

Critical Power / Power Control & Safety / Energy Efficiency

Tel. +971 4 29 98 441
Fax +971 4 29 98 449
info.ae@socomec.com

IN AMERICA

USA, CANADA & MEXICO

Power Control & Safety / Energy Efficiency

Tel. +1 617 245 0447
Fax +1 617 245 0437
info.us@socomec.com

OTHER COUNTRIES

NORTH AFRICA

Algeria / Morocco / Tunisia
info.naf@socomec.com

AFRICA

Other countries
info.africa@socomec.com

SOUTH EUROPE

Cyprus / Greece / Israel / Malta
info.se@socomec.com

SOUTH AMERICA

Tel. +34 93 540 75 75
info.es@socomec.com

MORE DETAILS

www.socomec.com/worldwide

HEAD OFFICE

SOCOMECH GROUP

SAS SOCOMECH capital 10 686 000 €
R.C.S. Strasbourg B 548 500 149
B.P. 60010 - 1, rue de Westhouse
F-67235 Benfeld Cedex - FRANCE
Tel. +33 3 88 57 41 41
Fax +33 3 88 74 08 00
info.scp.isd@socomec.com

www.socomec.com

YOUR DISTRIBUTOR / PARTNER

your energy
our expertise

