

# INOSYS LBS

PV / DC switches with tripping function – 100 to 1250A

IEC: 84Pxxxx / IEC & UL: 85Pxxxx

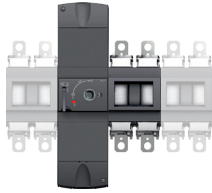

① IEC: 160 / 250 / 315A  
UL: 100 / 200 / 250A

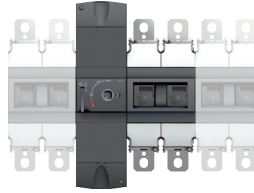

② IEC: 400 / 630 / 800A  
UL: 275 / 400 / 500 / 600A

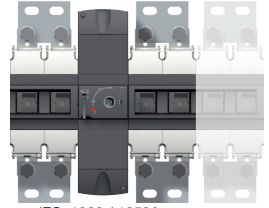

③ IEC: 1000 / 1250A  
UL: 800 / 1000A

**⚠ DANGER / DANGER / PELIGRO**

**EN** This equipment must be installed and serviced only by qualified electrical personnel.

**⚠ HAZARDOUS VOLTAGE**

- Turn off all power supplying this equipment before working on or inside equipment.
- Always use a properly rated voltage sensing device to confirm power is off.
- Replace all devices, doors, and covers before turning on power to this equipment.
- Maintain electrical clearances between cable and live parts.
- Unless otherwise noted, use the screws and nuts provided.
- As a general rule to low voltage insulation safety, auxiliary contacts position are not a safety device. When used to report the position of the main contacts, additional measures such as padlocking or checking that the installation is proven dead, must be taken.

**Failure to follow these instructions will result in death or serious injury.**

**FR** L'installation et l'entretien de cet appareil ne doivent être effectués que par du personnel qualifié.

**⚠ TENSION DANGEREUSE**

- Coupez l'alimentation de cet appareil avant d'y travailler.
- Utilisez toujours un dispositif de détection de tension à valeur nominale approprié pour confirmer que toute alimentation est coupée.
- Remplacez tous les dispositifs, les portes et les couvercles avant de mettre cet appareil sous tension.
- Maintenez les distances d'isolement électrique entre le câble et les pièces sous tension.
- Dans les règles générales pour l'isolement de sécurité en basse tension, les contacts auxiliaires ne sont pas des dispositifs de sécurité. Lorsqu'ils sont utilisés pour signaler le positionnement de contacts principaux, des mesures supplémentaires telles que le cadenassage ou la vérification que l'installation est coupée, doivent être prises en compte.

**Si ces précautions ne sont pas respectées, cela entraînera la mort ou des blessures graves.**

**ES** Este equipo debe ser instalado y operado únicamente por personal cualificado.

**⚠ TENSION PELIGROSA**

- Desconectar cualquier suministro eléctrico al equipo antes de trabajar con el mismo.
- Utilizar siempre un multímetro correctamente calibrado para confirmar que el equipo no está alimentado.
- Vuelva a colocar todos los dispositivos, puertas y cubiertas antes de volver a dar tensión al equipo.
- Mantenga las distancias eléctricas adecuadas entre el cable y las partes activas.
- A menos que se indique lo contrario, utilice los tornillos y tuercas.
- Como norma general para el aislamiento de seguridad en baja tensión, los contactos auxiliares de posición no son un dispositivo de seguridad. Cuando son utilizados para indicar la posición de los contactos, deben tomarse medidas adicionales como el bloqueo por candado o la comprobación de que la instalación está totalmente aislada.

**No seguir estas instrucciones puede provocar daños graves e incluso la muerte.**



**Switch and accessories**  
**L'interrupteur et ses accessoires**  
**El interruptor y sus accesorios**

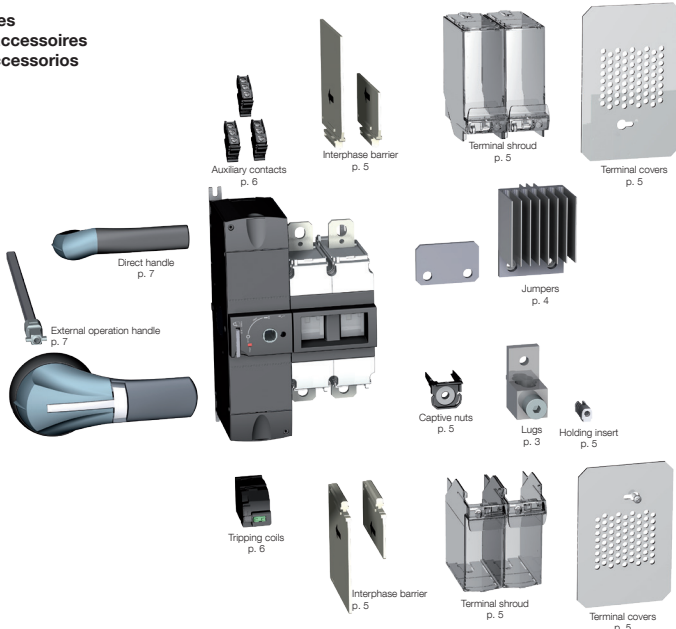

Keep the instruction sheet, it is necessary for the mounting of the accessories. Non contractual document.  
Ne jetez pas cette notice: elle sera nécessaire pour le montage des accessoires. Document non contractuel.  
No tirar este manual, porque es necesario para el montaje de los accesorios. Documento no contractual.

**Dual dimensions in/mm**  
**Double dimensions in/mm**  
**Dimensiones duales in/mm**

- ① Interphase barrier  
Ecrans entre phase  
Pantallas de separación entre pletinas
- ② Terminal screens  
Ecran de protection de plaques  
Pantallas de protección
- ③ Terminal shroud  
Caches bornes  
Cubrebornes
- ④ Double terminal shroud  
Caches bornes doubles  
Cubrebornes doble

		A				A1				J				J1	
		1 P	2 P	3 P	4 P	1+1 P	1+2 P	1+3 P	2+2 P	1 P	2 P	3 P	4 P	1 P	2 P
①	in	4.02	5.39	6.77	8.15	5.39	6.77	8.15	8.15	2.07	3.45	4.83	6.21	2.74	4.12
	mm	102	137	172	207	137	172	207	207	53	88	123	158	70	105
② ③	in	4.41	6.18	7.95	9.72	6.18	7.95	9.72	9.72	2.47	4.24	6.01	7.78	3.14	4.91
	mm	112	157	202	247	157	202	247	247	63	108	153	198	80	125

		B	B1	B2			B3	B4	C		J2	J3	J4	J5	J6	J7	J8	P	P1	P2
				IEC short	IEC long	UL			IEC	UL										
①	in	9.69	13.35	7.85	12.61	10.31	11.64	10.60	4.33	4.33	2.36	1.38	3.03	3.23	4.72	0.39	0.58	0.12	1.38	5.87
	mm	246	339	199	320	262	296	269	110	110	60	35	77	82	120	10	15	3	35	149
② ④	in	9.69	16.28	9.35	14.11	15.50	14.12	15.95	4.33	5.31	2.76	1.77	3.43	4.72	6.22	0.16	0.33	0.20	1.77	7.87
	mm	246	414	237	358	394	359	405	110	135	70	45	87	120	158	4	8	5	45	200

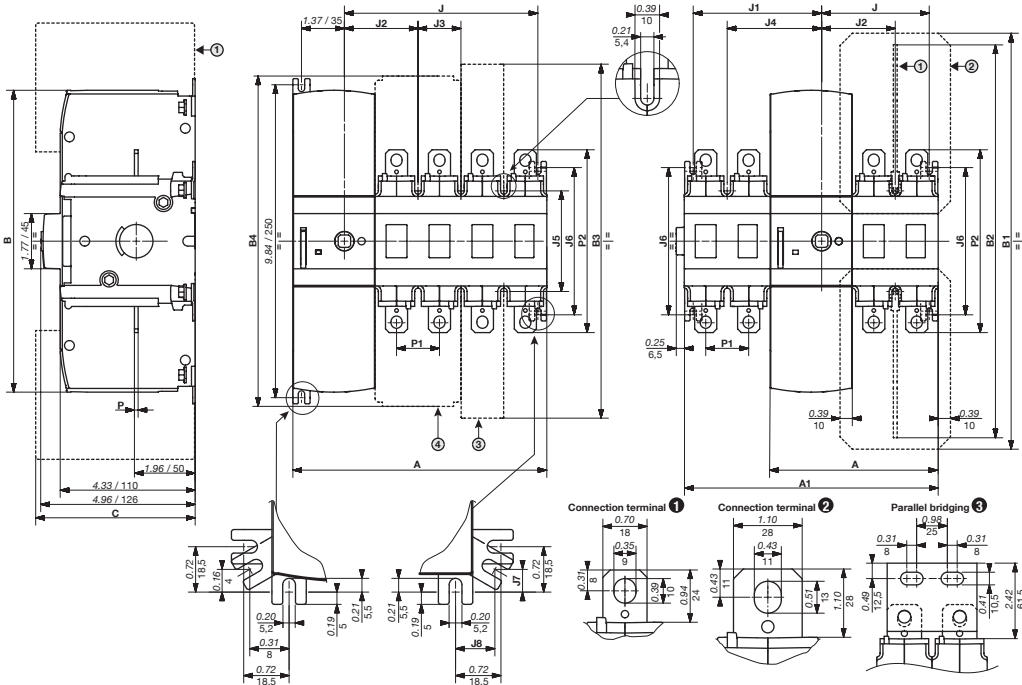

**Minimum enclosure dimensions UL98B / Dimensions minimum des coffrets UL98B**

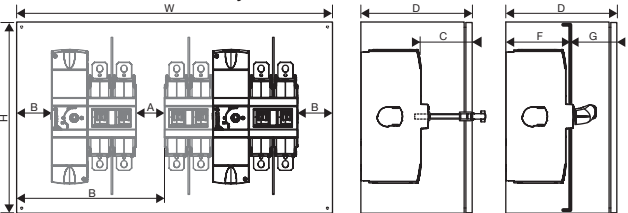

Minimum enclosure size	①		② ③				
	100-250A	275A	400A	500A	600A	800-1000A	
H x W x D	in 24x16x6	40x24x8	36x24x8	36x24x8	48x36x12	/	
	mm 609x406x152	1016x609x203	914x609x203	914x609x203	1219x914x305		
H x W x D	in 24x16x6	36x24x8	36x24x8	36x24x8	48x36x12	48x36x12	
	mm 609x406x152	914x609x203	914x609x203	914x609x203	1219x914x305	1219x914x305	
H x W x D	in 24x16x6	40x24x8	36x24x8	36x24x8	60x36x20		
	mm 609x406x152	1016x609x203	914x609x203	914x609x203	1524x914x508		
H x W x D	in 24x16x6	36x24x8	36x24x8	48x36x12	60x36x20		
	mm 609x406x152	914x609x203	914x609x203	1219x914x305	1524x914x508		

Clearance	①		② ③	
	in	mm	in	mm
A min.	2.00	50.8	2.00	50.8
B min.	1.00	25.4	1.00	25.4
C min.	0.87	22	1.08	27.5
F min.	4.33	110	5.41	137.5
G min.	2.56	65	2.56	65

External enclosure dimension.  
Dimension extérieure du coffret.

**Mounting / Montage / Montaje**

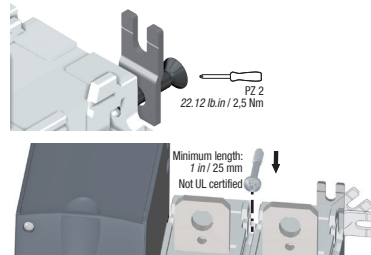

**Mounting orientation / Sens de montage**  
**Sentido de montaje**

All mounting orientations are possible.  
Derating may apply - please consult us.



**Connection with LUGS (UL application) - Raccordement avec bornes à cage (application UL) - Conexión con bornes (aplicación UL)**

**⚠ CHECK FOR PROPER ELECTRICAL CLEARANCES.** For applications up to 1500V, maintain at least 1" clearance between adjacent power terminal lugs and at least 0.500" clearance between any live part and the device enclosure. **⚠ VERIFIER LES DISTANCES D'ISOLEMENT.** Jusqu'à 1500V il faut maintenir au minimum 25,4 mm entre chaque borne et 12,7 mm entre chaque pièce sous tension et le coffret. **⚠ VERIFICAR LAS DISTANCIAS DE AISLAMIENTO.** Hasta 1500V es necesario mantener como mínimo 1" de distancia entre cada borne y 0,500" entre cada una de las piezas bajo tensión y la caja.

	Designation Designation Designación	Ref. lugs (1) Réf. bornes à cage (1) Ref. bornes (1)	Accessories (2) Accessoires (2) Accesorios (2)	Quantity per reference Quantité par réf Cantidad por referencia	Openings per lug Nombre de points de connexion Numero de puntos de conexión	Size Section Sección (AWG) Cu/Al		Pressure screw torque Couple de serrage vis de pression Par de apriete tornillo de presión			Bolt torque Couple de serrage boulon Par de apriete tornillo				
						min.	max.	lb.in	Nm	Size	lb.in	Nm	Size	in	mm
①		39542020	-	2	1	6	300 KCMIL	275	31,1	○ 5/16	160	18	● 13	1,31	33,4
		39543020	-	3											
		39544020	-	4											
		39546020	-	6											
②		39542023 (3)	-	2	2	Cu:14, Al:12	10	35	40	○ 3/16	160	18	● 13	1,29	32,5
		39543023 (3)	-	3											
		39544023 (3)	-	4											
		39546023 (3)	-	6											
②		39542040 (3)	-	2	1 2	4 1/0	600 KCMIL 250 KCMIL	550	62,1	○ 1/2	310	35	● 15 17	1,79	45,7
		39543040 (3)	-	3											
		39544040 (3)	-	4											
		39542015	39540039 (up to 3 lugs) (4)	2											
39543015	-	3													
③		39542060 (3)	-	2	2	2	600 KCMIL	550	62,1	○ 3/8	310	35	● 15 17	2,74	69,7
		39543060 (3)	-	3											
		39544060 (3)	-	4											

(1) Interphase barriers must be installed on the products / Les écrans entre phase doivent être installés sur les produits. (2) Not compatible with captive nut 84996xxx / Non compatible avec écrou captif 84996xxx. (3) Captive nut 84996xxx is mandatory (see page 5) / Ecrou captif 84996xxx est obligatoire (voir page 5). (4) Accessory is mandatory to mount the lugs on the product terminal / Accessoire obligatoire pour monter le lugs sur les bornes de produit.

**Without accessories**

**With accessories**

400A UL98B

500-600A UL98B

**Recommended connection with cables or bars (IEC application)  
Raccordement câble ou barre recommandé (application CEI)  
Conexión recomendada para cables y pletinas (aplicación IEC)**

Ie	Nominal Cu cable section Section nominale câbles rigides Cu Sección máx. de cables de cobre rígidos	Nominal Al cable section Section nominale câbles rigides Al Sección máx. de cables de Alu. rígidos	Maximum busbar width Largeur max. barre Largo máx. barra		Tightening torque Couple de serrage Par de apriete	Size
			Non isolated bars	Isolated bars with interphase barrier		
①	160A	70mm <sup>2</sup>	120mm <sup>2</sup>		159,31 lb.in 18 Nm	● 13
	250A	120mm <sup>2</sup>	185mm <sup>2</sup>			
	315A	185mm <sup>2</sup>	2 x 120mm <sup>2</sup>			
②	400A	240mm <sup>2</sup>	2 x 150mm <sup>2</sup>		309,77 lb.in 35 Nm	● 15-17
	630A	2 x 185mm <sup>2</sup>	2 x 300mm <sup>2</sup>			
	800A	2 x 240mm <sup>2</sup>	3 x 240mm <sup>2</sup>			
③	1000A Bars section: 2 x 300mm <sup>2</sup> (e.g 2 x 60mm x 5mm)	Bars section: 2 x 500mm <sup>2</sup> (e.g 2 x 50mm x 10mm)	≤ 70mm	≤ 80mm		
	1250A Bars section: 2 x 400mm <sup>2</sup> (e.g 2 x 80mm x 5mm)	Bars section: 2 x 800mm <sup>2</sup> (e.g 2 x 80mm x 10mm)				

# Mounting of jumpers - Montage des barres de pontage - Montaje de las pletinas de unión



		1 PV circuit - 1000 VDC		2 PV circuits - 1000 VDC		1 PV circuit - 1500 VDC		Tightening torque Couple de serrage Par de apriete	Size	
		Ref.	Fig.	Ref.	Fig.	Ref.	Fig.			
1	UL	100A / 200A	84090016	A	84090016	A	84090016	159.31 lb.in 18 Nm	13	
		250A			84090025 84090031	B	84090025 84090031			B
	IEC	160 / 250 / 315A			84090016	A	84090016	A		
2	UL	275A	84090040	A	84090040	A	84090040	309.77 lb.in 35 Nm	15-17	
		400A			84090041	B	84090041			B
		500A	84090041	B	84090041	B				
	IEC	600A	84090063	B	84090063	B	84090063			B
		400A	84090063	B	84090063	B	84090063			B
		630 A								
3	UL	800A	84090041	D			84090040	A		
		1000A					84090041	B		
	IEC	1000 / 1250A		C						

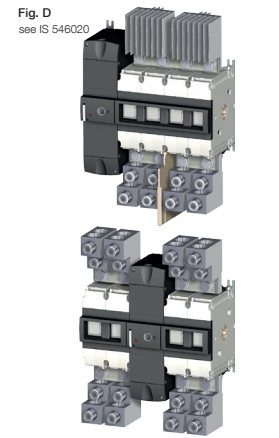
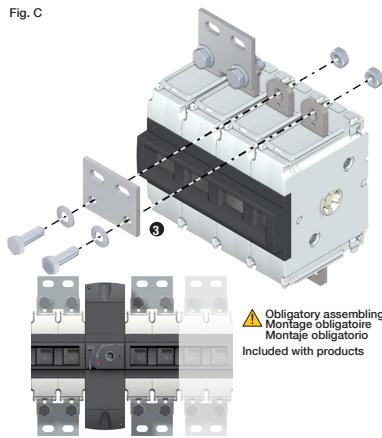
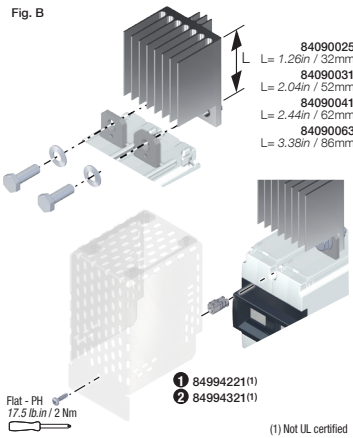
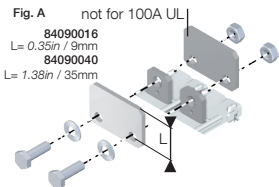

## Pole connection in series - Configuration raccordement - Conexión de los polos en serie

**⚠ COMPULSORY**  
For comprehension reason, only one type of connection is shown. As all poles are independent and non polarized, the pole connections in series can be done between adjacent or non-adjacent poles and on the same or opposite side of the product. The minimum number of pole to be connected in series must be as shown below for the given technical characteristics. Wire bending space as well as spacings have to be according to NEC or relevant installation standard. For this, the enclosure dimension might have to be increased.  
For bridging bar and serial connections not supplied by Socomec, thermal effect have to be checked.  
For multi-circuit products, the signs ①, ② represent wiring for each circuit.  
2 or more separated circuits can also be connected together on the inverter side.  
**⚠** For multiple polarity switching (ungrounded systems or multiple circuit switching), interphase barrier must be installed before energizing

**⚠ OBLIGATOIRE**  
Pour une meilleure compréhension, seul un type de raccordement est décrit. Tous les pôles sont indépendants et non polarisés, le raccordement des pôles en série peut être réalisé entre pôles adjacents ou non, sur le même côté ou le côté opposé du produit. Le nombre minimum de pôles à raccorder en série doit correspondre aux indications ci-dessous pour les caractéristiques techniques mentionnées. Le rayon de courbure des câbles ainsi que les distances entre conducteurs/parois doivent être selon le NEC ou la norme d'installation. Pour cela, la dimension minimum du coffret pourrait être augmentée. Pour les connexions série entre pôles/barres de pontages non fournis par Socomec, les impacts thermiques doivent être vérifiés.  
Pour les produits multi-circuits, les chiffres ①, ② indiquent le raccordement de chaque circuit.  
2 circuits ou plus peuvent aussi être connectés ensemble du côté de l'onduleur.  
**⚠** Pour la coupure de plusieurs polarités (réseau isolé avec coupure du + et - ou coupure de plusieurs circuits), les écrans entre phase doivent être installés sur le produit.

**⚠ OBLIGATORIO**  
Para mayor claridad, sólo se describe un tipo de conexión. Todos los polos son independientes y sin polarización así que la conexión de los polos en serie se puede realizar entre polos que están contiguos o no, en el mismo lado o en el lado opuesto del producto. El número mínimo de polos a conectar en serie debe corresponder a las siguientes indicaciones para las características técnicas mencionadas. El radio de curvatura de los cables y las distancias entre las partes activas y pasivas respetar las normas de instalación NEC. Por ello, la dimensiones mínimas de la envolvente deberían ser aumentadas. Para la conexión serie entre los polos / pletinas de puenteado no suministradas por Socomec deben ser verificados los efectos térmicos.  
Para productos con multi-circuitos, las cifras ①, ② y representan la conexión de cada circuito.  
2 o varios circuitos separados se pueden conectar juntos en el lado del inversor.  
**⚠** Para cortar varias polaridades (red aislada o corte multi-circuitos), se deben instalar los cubrebornes en el producto.

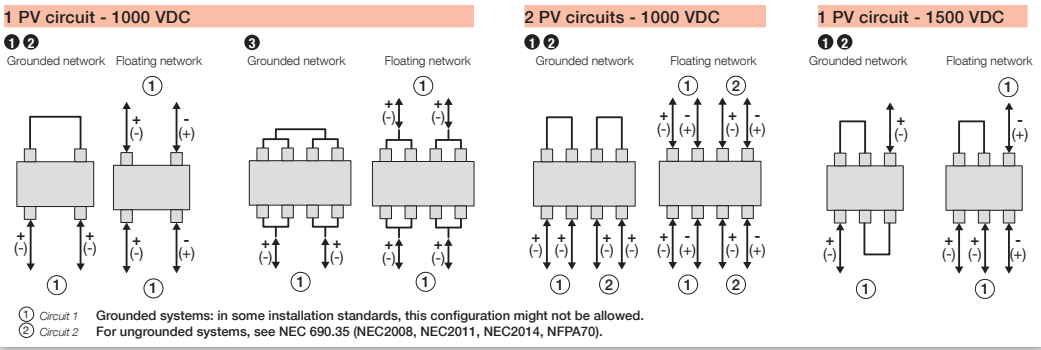

**Voltage taps**  
**Cosse prise tension**  
**Kit de toma de tensión**

	Ref.
①	84999012 (1)
② ③	84999013 (1)

FASTON  
 0.25x0.03 in  
 6.3x0.8 mm

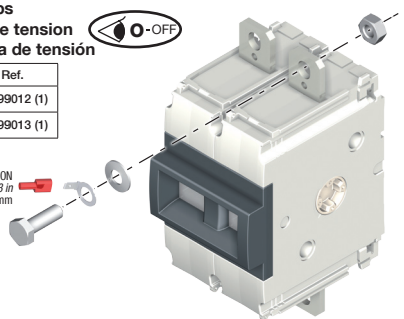

**Mounting of captive nuts**  
**Montage écrou captif**  
**Montaje de las tuercas cautivas**

	Ref.
①	8499612x
② ③	8499613x

Tightening torque  
 see: page 3

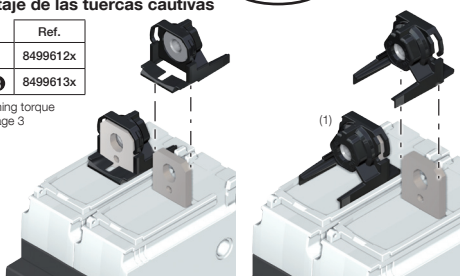

**Interphase barrier mounting**  
**Montage des écrans entre phase**  
**Montaje de pantalla de separación entre pletinas**

For products not delivered with interphase barriers, the reference are:

	Ref.	Set of	Size
① ②	84992202	2	Short
	84992203	3	
	84992212	2	
① ② ③	84992213	3	Long

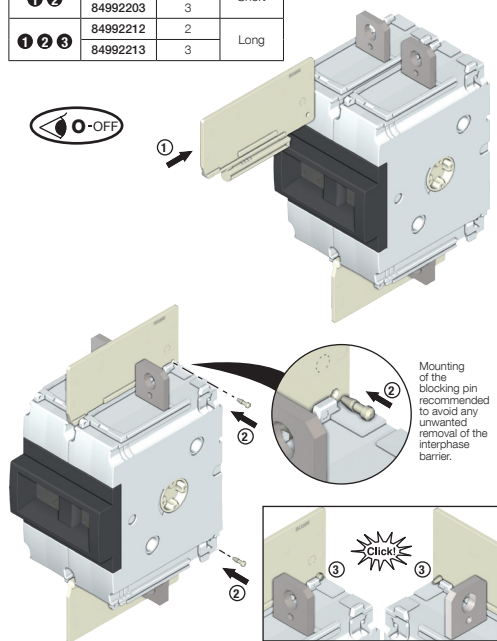

Mounting of the blocking pin recommended to avoid any unwanted removal of the interphase barrier.

**Terminal shroud mounting**  
**Montage des caches bornes**  
**Montaje cubrebornes**

	Ref.	Nb of poles	Position
①	849942x3	3	Top or bottom
	849942x4	4	
	849943x3	3	
②	849943x4	4	

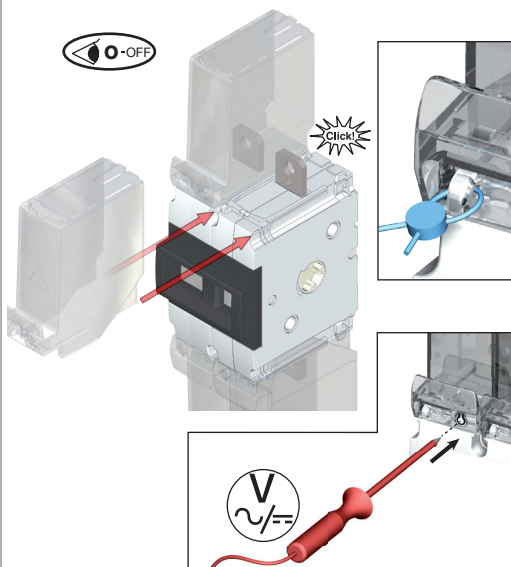

**Mounting of holding insert**  
**Montage chevilles**  
**Montaje de las clavijas**

	Ref.
① ② ③	8499622x

Note: when used, will block the interphase barrier or terminal shrouds

② Flat - PZ 2  
 17.5 lb.in / 2 Nm

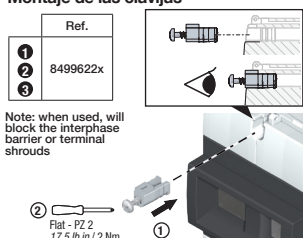

**Mounting of terminal covers**  
**Montage des capots**  
**Montaje de las pantallas de protección**

	Ref.	Nb of poles	Position
	84993222	2P	Top and bottom
①	84993232	3P	
	84993242	4P	
	84993322 (1)	2P	
	84993332 (1)	3P	
	84993342 (1)	4P	
② ③	84993722	2P	
	84993732	3P	
	84993742	4P	

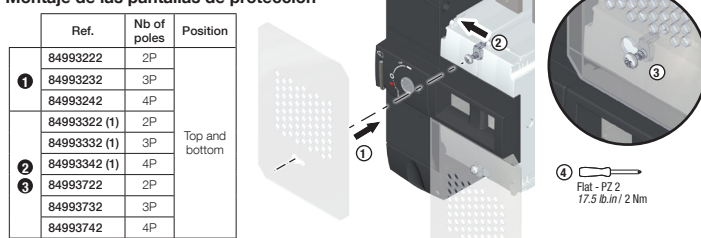

④ Flat - PZ 2  
 17.5 lb.in / 2 Nm

# Mounting of auxiliary contacts Montage des contacts auxiliaires Montaje de los contactos auxiliares



	Ref.	Type
1	84990001	NO/NC standard
2	84990002	NO/NC low level
3	84990003	NC 600V

Line terminals of the two auxiliary contacts placed side by side must be of the same polarity. Surrounding temperature max: 75 °C (UL only).

Les raccordements entre deux contacts auxiliaires côte à côte doivent être de la même polarité. Température de proximité max: 75 °C (UL seulement).

Conexiones de entrada de los contactos auxiliares adyacentes deben ser de la misma polaridad. Temperatura cerca max: 75 ° C (sólo UL).



84990001  
84990002



84990003

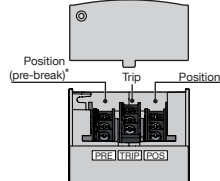
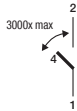

\* Pre-break only for manual operation

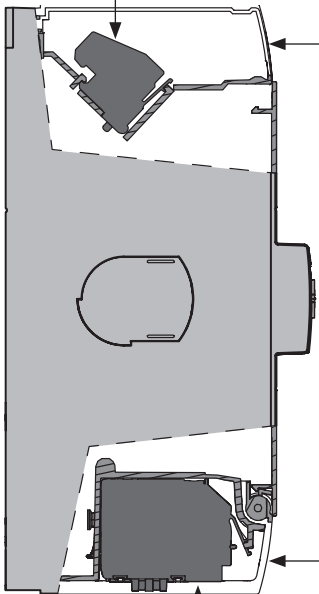

Cu cable section - 75 °C or higher  
Section cables Cu - 75 °C ou plus  
Ith = 10A

**Flexible, with cable end**

(IEC only)  
min 1x 0,5 mm<sup>2</sup>  
max 1x 2,5 mm<sup>2</sup> / 2x 1,5 mm<sup>2</sup>

**Stranded/Solid** (IEC / UL)

AWG max 1x 14 / 2x 16  
min 1x 0,5 mm<sup>2</sup> / 2x 1,5 mm<sup>2</sup>  
max 1x 2,5 mm<sup>2</sup> / 2x 2,5 mm<sup>2</sup>  
0.31in / 8mm



Flat 5 - PZ 2 - 7.08 lb.in / 0,8 Nm

## Mounting / Montage / Montaje

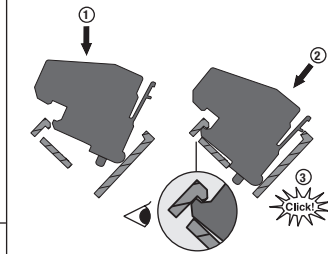

## Dismounting / Démontage / Desmontar

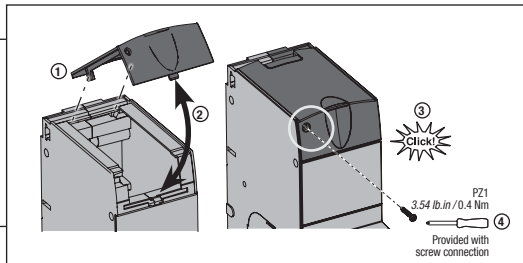
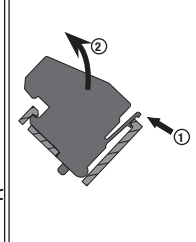

# Tripping coils mounting Bobines de déclenchement Bobinas de disparo



	Ref.	
1	84997xxx	Shunt trip coil Bobine de déclenchement Bobina de emisión
2		Undervoltage release Bobine à manque
3	84998xxx	Bobina de disparo de mínima tensión

⚠ Shunt trip coil must not be permanently powered, Max supply = 2sec /min.  
Example to avoid permanent supply includes connection of auxiliary contact connected in series with shunt trip coil, or coil supply voltage to be taken from the load side, or electronic limitation of the duration of the supply voltage/current.  
For DC shunt trip coil rated above 70VDC, external relay shall be used to disconnect the coil.

## Mounting / Montage / Montaje

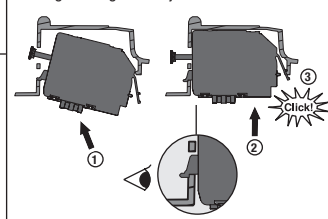

## Dismounting / Démontage / Desmontar

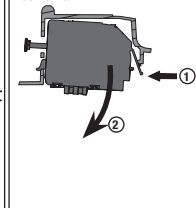

Cu cable section  
Section cables Cu  
Sección de cables de cobre

Non polarized coil, all wiring possible.

**Flexible, with cable end** (IEC only)

min 0,25 mm<sup>2</sup>  
max 1,5 mm<sup>2</sup>

**Stranded/Solid** (IEC / UL)

AWG min 26  
AWG max 14  
min 0,14 mm<sup>2</sup> - max 2,5 mm<sup>2</sup>  
0.31in / 8mm

**Direct handle mounting**  
**Montage poignée direct**  
**Montaje mando directo**

	Ref.	Color
1	849950x2 (1)	Black
2	849950x3 (1)	Red

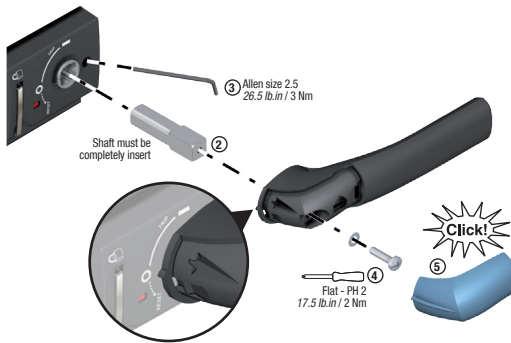
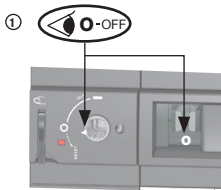

**Cover dismantling**  
**Démontage du capot**  
**Desmontar la cubierta**

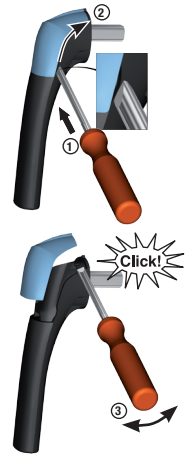

**External operation handle**  
**Commande frontale**  
**Mando frontal**

	Ref.	Color
1	74212118 (1)	Black
2	74A12118 (1)	
3	742F2118	
4	742AF2118	
5	742G2118	Red
6	74AG2118	
7	742D2118	Black
8	74AD2118	
9	742E2118	Red
10	74AE2118	

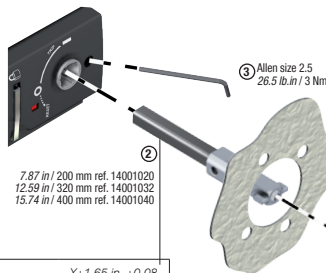
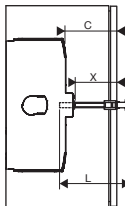

$$\text{Size (L)} = X + 1.65 \text{ in} \pm 0.08$$

$$X + 42 \text{ mm} \pm 2$$

X = External enclosure dimension -  
 Dimension extérieure du coffret.  
 (mini: 1.18 in / 30 mm)

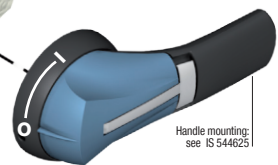
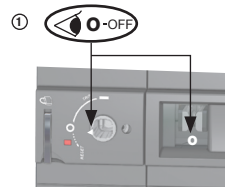

**Padlocking on handle or product**  
**Cadenassage sur produit ou poignée**  
**Enclavamiento sobre el producto**  
**o sobre el mando**

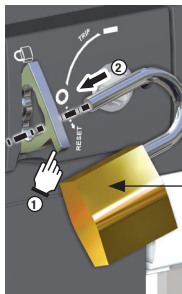

min: 1x Ø 0.16 in / Ø 4 mm  
 max: 2x Ø 0.24 in / Ø 6 mm  
 1x Ø 0.31 in / Ø 8 mm

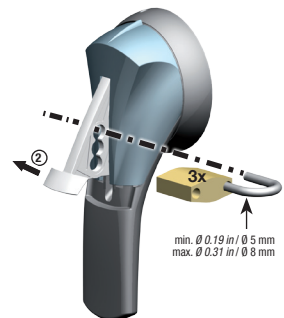

**Verification of the product and its installation before power ON**  
**Vérification du produit et de son installation avant mise en service**  
**Verificación del producto y de su instalación antes de la puesta en marcha**

**EN** This equipment must be installed and serviced only by qualified electrical personnel.  
**⚠** After the installation of the product or one of its accessories, verify the operation of the product will ensure a safe commissioning and prevent malfunctions or assembly errors.

**FR** L'installation et l'entretien de cet appareil ne doivent être effectués que par du personnel qualifié.  
**⚠** Après l'installation du produit, ou d'un de ses accessoires, vérifier le fonctionnement du produit pour assurer une mise en service sécurisée et éviter des dysfonctionnements ou des erreurs de montage.

**ES** Este equipo debe ser instalado y operado únicamente por personal cualificado.  
**⚠** Después de la instalación del producto o de los accesorios, se recomienda comprobar el funcionamiento del producto para asegurar una puesta en marcha segura y evitar malos funcionamientos o errores de montaje.

**1) Mechanical check**









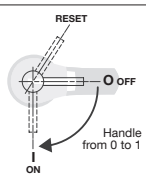
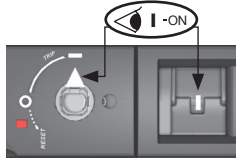

The product must be operated manually, the different positions of the product should be verified on the product and auxiliary contacts: position of the handle / shaft; position of power contacts & auxiliary contacts.  
 The operations to perform are: 1 closing, 1 opening, 1 closing, 1 tripping (action on the push to trip button) and 1 reset.

**1) Vérification mécanique**

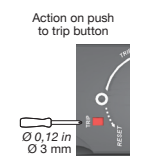
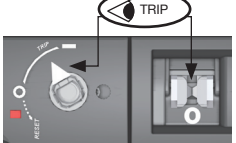
Le produit doit être manœuvré manuellement, les différentes positions du produit doivent être vérifiées sur le produit ainsi que les contacts auxiliaires: position de la poignée/axe de commande; position des contacts de puissance & contacts auxiliaires.  
 Les manœuvres à effectuer sont: 1 fermeture, 1 ouverture, 1 fermeture, 1 déclenchement (action sur le bouton «push to trip») et 1 réarmement (reset).

**1) Verificación mecánica**

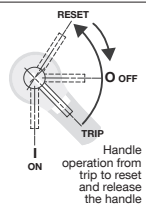
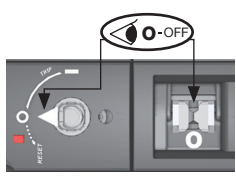
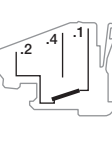
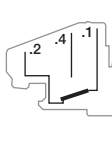
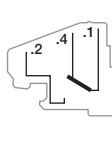
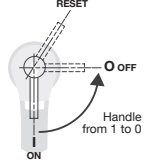
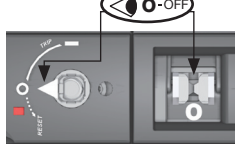
Se necesita accionar el producto manualmente y comprobar las posiciones del producto y de los contactos auxiliares: posición del mando/eje prolongado; posición de los contactos de potencia & contactos auxiliares.  
 Se deben realizar las siguientes maniobras: 1 cierre, 1 apertura, 1 cierre, 1 disparo (acción en el botón «push to trip») y 1 reseteo.

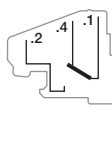
Action to be performed Action à effectuer Acción a realizar	Final state of the product Etat final du produit Estado final del producto	State auxiliary contact			Padlock feature on the product
		PRE (Pre-break)	TRIP (Trip position)	POS (contact ON position)	
 <p>RESET ON OFF Handle from 0 to 1</p>	 <p>ON</p>				NO
 <p>Action on push to trip button Ø 0,12 in Ø 3 mm</p>	 <p>TRIP</p>				NO
 <p>RESET ON OFF Handle operation from trip to reset and release the handle</p>	 <p>OFF</p>				Possible
 <p>RESET ON OFF Handle from 1 to 0</p>	 <p>OFF</p>				Possible

**2) Electrical check**

In addition to the mechanical check, electrical operation of the product should be performed by testing the tripping function using the coil (supplied by the correct voltage).  
 Shunt trip coil must not be permanently powered, Max supply = 2 sec.

**2) Vérification électrique**

En complément des vérifications mécaniques, le fonctionnement électrique du produit doit être vérifié, en testant le déclenchement à l'aide de la bobine de déclenchement (l'alimenter par la tension adéquate).  
 La bobine de déclenchement à émission ne doit pas être alimentée en permanence, Max = 2 sec.

**2) Verificación eléctrica**

Además de las verificaciones mecánicas, también se debe comprobar el funcionamiento eléctrico del producto, accionando la bobina de disparo (con la adecuada tensión).  
 No se debe alimentar continuamente la bobina de emisión (Max = 2 sec.)

**3) Periodic check**

During installation operation or after a long period of shutdown, maintenance is recommended and consist in mechanical and electrical check as described above (recommended frequency for maintenance: 1 times per year).

**3) Vérification périodique**

En cours d'exploitation et selon les règles en vigueur ou après un arrêt prolongé ou un défaut, il est recommandé de faire les vérifications ci-dessus (recommandé 1 fois par an).

**3) Verificación periódica**

Cuando el producto está funcionando y según las reglas vigentes o después de un paro prolongado o de un defecto, se recomienda realizar las verificaciones mencionadas más arriba (1 vez cada año).



# INOSYS LBS

带有跳闸功能的PV/DC开关 - 100至1250A

IEC : 84Pxxxxx / IEC & UL:85Pxxxxx

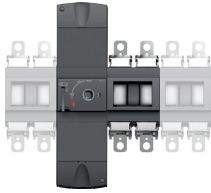

① IEC:160 / 250 / 315A  
UL:100 / 200 / 250A

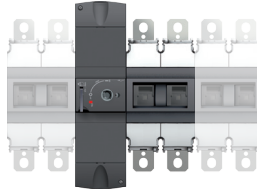

② IEC:400 / 630 / 800A  
UL:275 / 400 / 500 / 600A

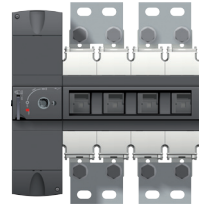

③ IEC:1000 / 1250A  
UL:800 / 1000A

## ⚠ 危险

ZH 本设备必须由具备专业资质的人员进行安装与检修。

### ⚠ 危险电压

- 在设备上或设备中进行操作之前，必须关闭供应此设备的所有电源。
- 应始终使用适当的电压检测装置确认电路已关断。
- 开启本设备的电源之前，关闭所有的设备、机门和护盖。
- 电缆和带电零件之间应保持足够的电气间距。
- 除非另有说明，使用所提供的螺钉和螺母。
- 依据低压绝缘安全的通用规则，辅助位置触点并不是一个安全的装置。在用来指示主触点的位置时，必须使用附加的装置（例如挂锁装置）来保证设备是完全断电状态。

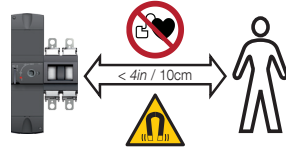

## 开关和附件

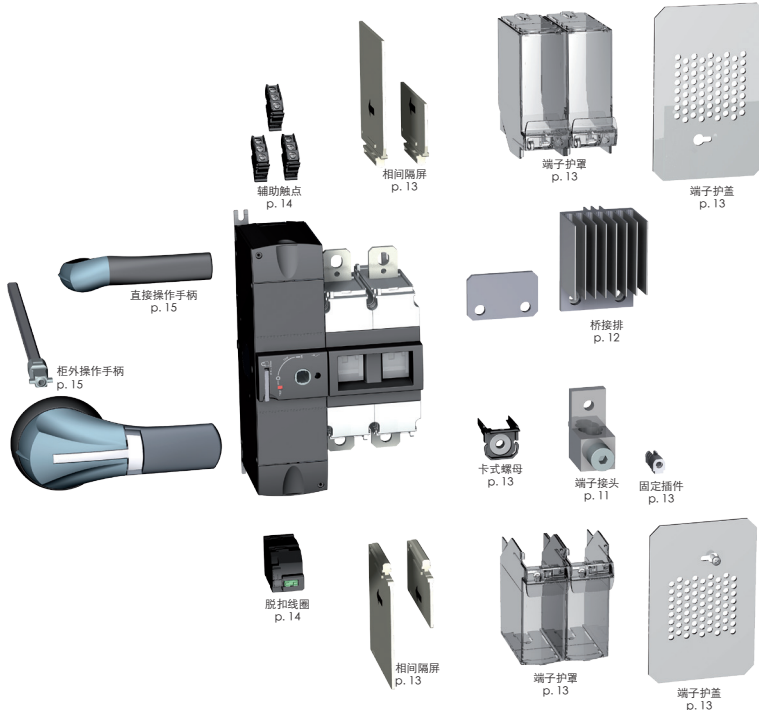

- ① 相间隔屏
- ② 端子护屏
- ③ 端子护罩
- ④ 双端子护罩

		A				A1				J				J1	
		1 P	2 P	3 P	4 P	1+1 P	1+2 P	1+3 P	2+2 P	1 P	2 P	3 P	4 P	1 P	2 P
①	in	4.02	5.39	6.77	8.15	5.39	6.77	8.15	8.15	2.07	3.45	4.83	6.21	2.74	4.12
②	mm	102	137	172	207	137	172	207	207	53	88	123	158	70	105
③	in	4.41	6.18	7.95	9.72	6.18	7.95	9.72	9.72	2.47	4.24	6.01	7.78	3.14	4.91
④	mm	112	157	202	247	157	202	247	247	63	108	153	198	80	125

		B	B1	B2			B3	B4	C		J2	J3	J4	J5	J6	J7	J8	P	P1	P2
				IEC短	IEC长	UL			IEC	UL										
①	in	9.69	13.35	7.85	12.61	10.31	11.64	10.60	4.33	4.33	2.36	1.38	3.03	3.23	4.72	0.39	0.58	0.12	1.38	5.87
②	mm	246	339	199	320	262	296	269	110	110	60	35	77	82	120	10	15	3	35	149
③	in	9.69	16.28	9.35	14.11	15.50	14.12	15.95	4.33	5.31	1.77	1.77	3.43	4.72	6.22	0.16	0.33	0.20	1.77	7.87
④	mm	246	414	237	358	394	359	405	110	135	70	45	87	120	158	4	8	5	45	200

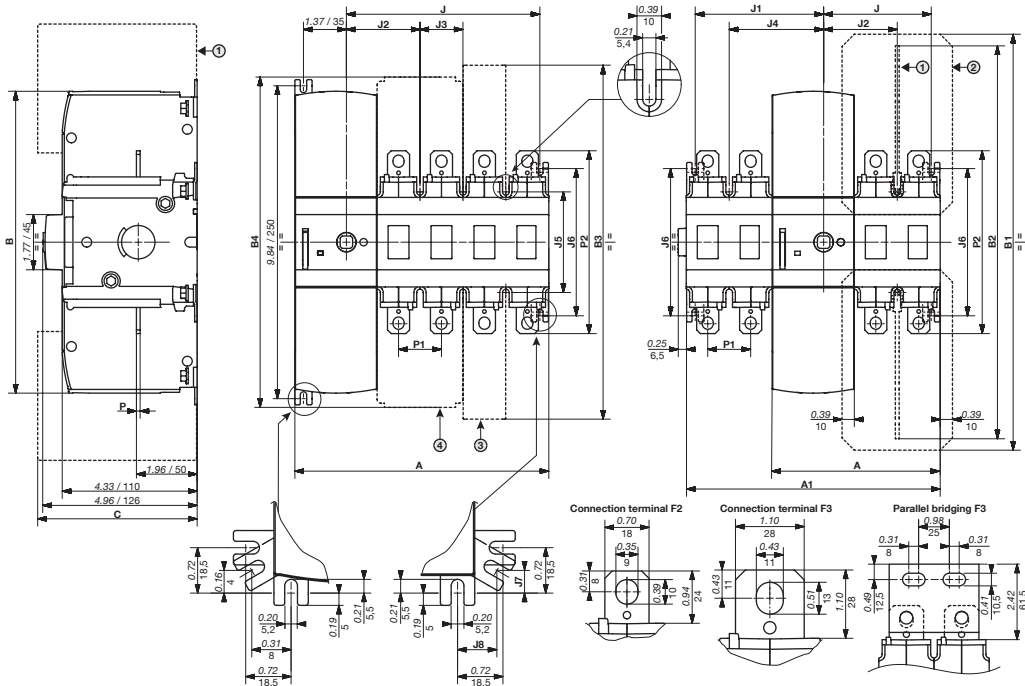

最小机壳尺寸UL98B

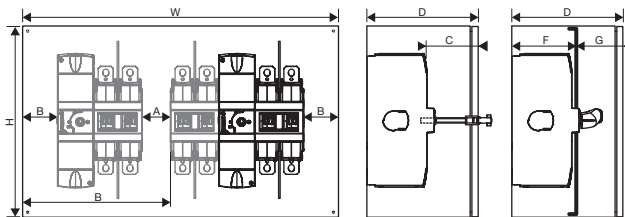

最小框架尺寸

		①		② ③					
		100-250A	275A	400A	500A	600A	800-1000A		
H x W x D	in	24x16x6	40x24x8	36x24x8	36x24x8	48x36x12	/		
H x W x D	mm	609x406x152	1016x609x203	914x609x203	914x609x203	1219x914x305	/		
H x W x D	in	24x16x6	36x24x8	36x24x8	36x24x8	48x36x12	48x36x12	/	
H x W x D	mm	609x406x152	914x609x203	914x609x203	914x609x203	1219x914x305	1219x914x305	/	
H x W x D	in	24x16x6	40x24x8	36x24x8	36x24x8	60x36x20	/		
H x W x D	mm	609x406x152	1016x609x203	914x609x203	914x609x203	1524x914x508	/		
H x W x D	in	24x16x6	36x24x8	36x24x8	48x36x12	60x36x20	/		
H x W x D	mm	609x406x152	914x609x203	914x609x203	1219x914x305	1524x914x508	/		

电气间隙

		①		② ③	
		in	mm	in	mm
A	最小	2.00	50.8	2.00	50.8
B	最小	1.00	25.4	1.00	25.4
C	最小	0.87	22	1.08	27.5
F	最小	4.33	110	5.41	137.5
G	最小	2.56	65	2.56	65

壳体尺寸

安装

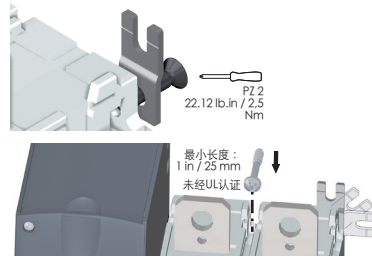

安装方向

可使用所有的安装方向。  
可能需要降容 - 请联系我们。

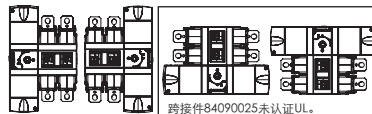

跨接件84090025未认证UL。

## 使用端子接头连接 (UL应用)

**⚠️** 检查电气间距是否正确。对于高达1500V的应用, 在相邻电源端子接头之间保持至少1"的间距, 以及在任何带电部件和设备机壳之间保持至少0.500"的间距。

标记	端子接头产品编号(1)	附件(2)	每个产品编号包含的数量	每个端子接头的开口	尺寸 (AWG) Cu9Al		压力螺钉力矩			螺栓力矩					
					最小	最大	lb.in	Nm	尺寸	lb.in	Nm	尺寸		in	mm
①	 CMC LA300-R	-	2	1	6	300 KCMIL	275	31.1	○ 5/16	160	18	● 13	1.31	33.4	
		39542020	-												2
		39543020	-												3
		39544020	-												4
②	 IHI 252-Q-TP-STK-34-49-HEX	-	2	2	Cu:14, Al:12	10	35	4	○ 3/16	160	18	● 13	1.29	32.5	
		39542023 (3)	-												2
		39543023 (3)	-												3
		39544023 (3)	-												4
②	 CMC LA630-R	-	2	1	4	600 KCMIL	550	62.1	○ 1/2	310	35	● 15-17	1.79	45.7	
		39542040 (3)	-												2
		39543040 (3)	-												3
		39544040 (3)	-												4
③	 接头支架和BRUMALL BS350TP	39540039 (多达3个接头) (4)	2	2	6	350 KCMIL	375	42.4	○ 3/8	310	35	● 15-17	2.87	72.8	
		39543015	-												3
		39542060 (3)	-												2
		39543060 (3)	-												3
③	 CMC PV2-400	-	2	2	2	600 KCMIL							2.74	69.7	
		39544060 (3)	-												4

(1) 必须在产品上安装相间隔屏 (2) 与卡式螺母84996xxx不兼容。(3) 卡式螺母84996xxx是强制性的 (请参阅p. 13)

(4) 附件是强制性的, 用于安装产品端子上的接头。

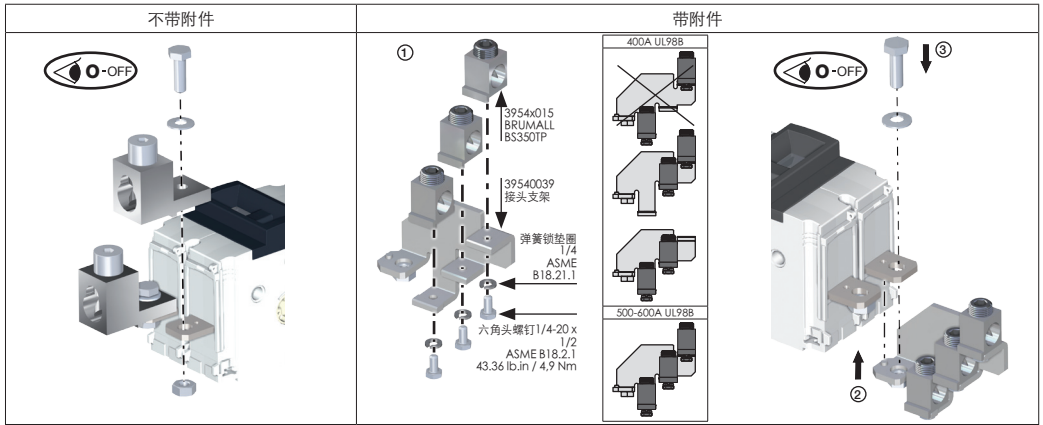

## 建议的电缆或铜排连接 (IEC应用)

le	额定铜电缆横截面	额定铝电缆横截面	最大母线宽度		拧紧力矩	尺寸
			非隔离铜排	带相间隔屏的隔离铜排		
①	160A	70mm <sup>2</sup>	≤ 20mm	≤ 25mm	159.31 lb.in 18 Nm	● 13
	250A	120mm <sup>2</sup>				
	315A	185mm <sup>2</sup>				
	400A	240mm <sup>2</sup>				
②	630A	2 x 185mm <sup>2</sup>	≤ 25mm	≤ 32mm	309.77 lb.in 35 Nm	● 15-17
	800A	2 x 240mm <sup>2</sup>				
	1000A	铜排横截面: 2 x 300mm <sup>2</sup> (例如2 x 60mm x 5mm)				
③	1250A	铜排横截面: 2 x 400mm <sup>2</sup> (例如2 x 80mm x 5mm)	≤ 70mm	≤ 80mm		

# 安装桥接排



		1个PV回路 - 1000 VDC		2个PV回路 - 1000 VDC		1个PV回路 - 1500 VDC		Tightening torque Couple de serrage Par de apriete	Size
		产品编号	图	产品编号	图	产品编号	图		
❶	UL	100A / 200A	84090016	A	84090016	A	84090016	159.31 lb.in 18 Nm	● 13
		250A			84090025	B	84090025		
	IEC	160 / 250 / 315A			84090031		84090031		
❷	UL	275A	84090040	A	84090040	A	84090040	309.77 lb.in 35 Nm	● 15-17
		400A			84090041	B	84090041		
		500A	84090063		84090063				
	600A	84090063		84090063					
	IEC	400A			84090041	A	84090041		
		630 A			84090063	B	84090063		
❸	UL	800 / 1000A	-	D					
	IEC	1000 / 1250A	84090041						
		1000 / 1250A	-	C					

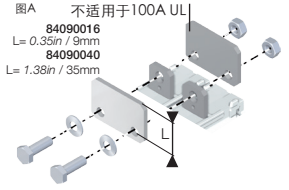

图B

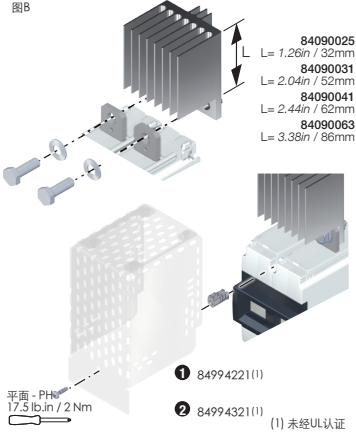

图C

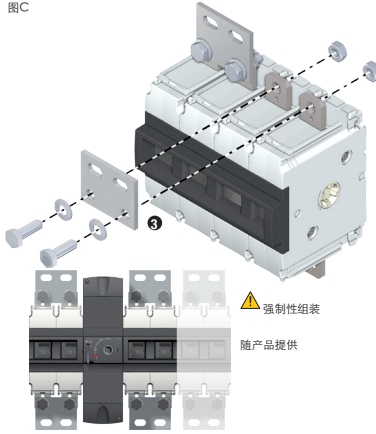

图D  
请参阅IS  
546020

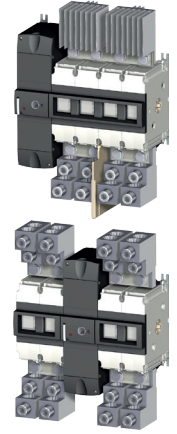

# 串联极

**强制性**  
为了易于理解，仅显示一种类型的连接。由于所有的极是独立和非极化的，因此，可将相邻或非相邻的极和产品的同侧或对侧的极串联。根据给定的技术特性串联最小级数，必须如下图所示。电线弯曲的空间以及间距必须根据NEC或相关的安装标准。为此，必须增加机壳尺寸。  
对于非洲高美索克曼提供的桥接排和串行连接，必须检查热效应。  
对于多回路产品，❶、❷符号代表每个回路的接线。  
还可将2个或更多独立的回路，一起连接到逆变器侧。

**强制性**  
对于多级开关（未接地系统或多回路开关），必须在通电前安装相间隔离。

## 1个PV回路 - 1000 VDC

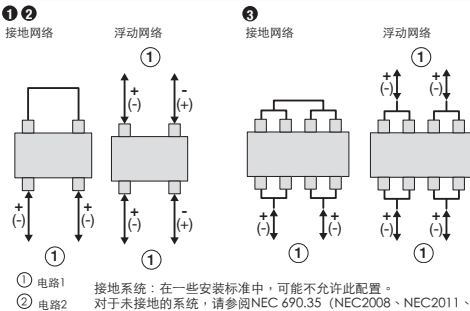

## 2个PV回路 - 1000 VDC

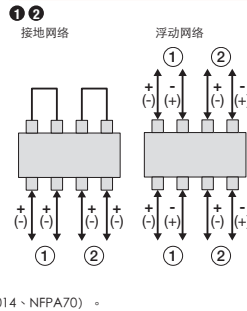

## 1个PV回路 - 1500 VDC

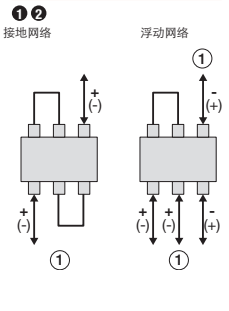

## 电压分接头

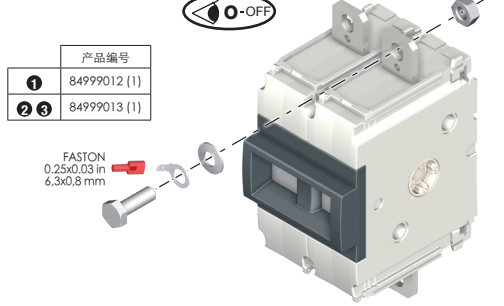

## 安装卡式螺母

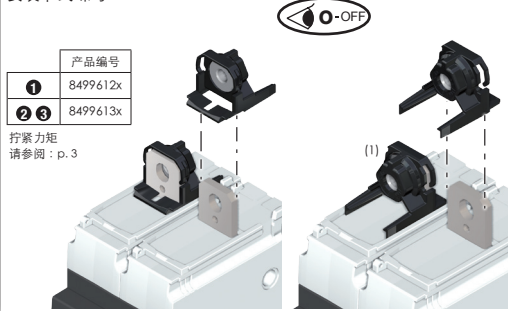

## 安装相间隔板

对于未提供相间隔板的产品，产品编号为：

	产品编号	一套	尺寸
① ②	84992202	2	短
	84992203	3	
① ② ③	84992212	2	长
	84992213	3	

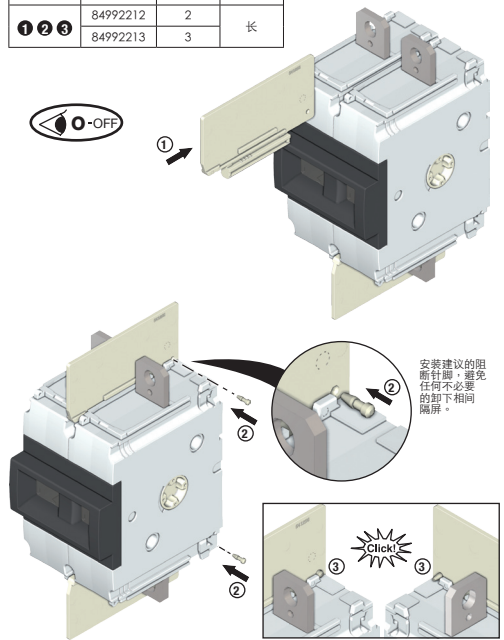

## 安装端子护罩

	产品编号	极数	位置
①	849942x3	3	顶部或底部
	849942x4	4	
	849943x3	3	
②	849943x4	4	

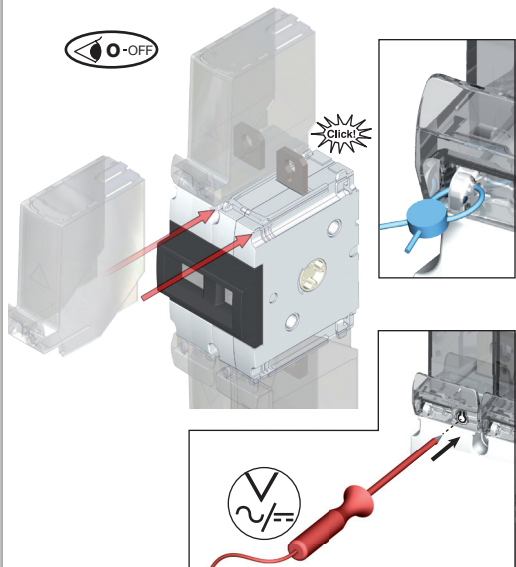

## 安装固定插件

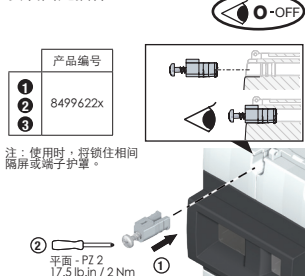

## 安装端子护盖

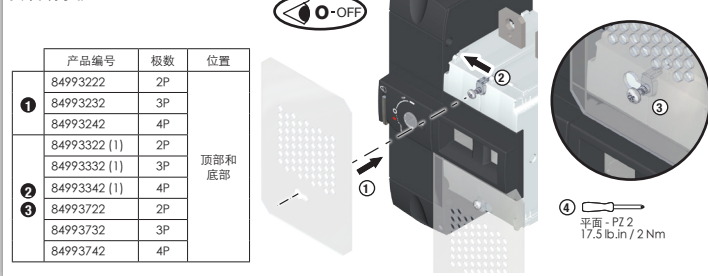

## 安装辅助触点

产品编号	类型
1 84990001	NO/NC标准
2 84990002	NO/NC低电平
3 84990003	NC 600V

并非放置的两个辅助触点的线路端子必须是相同的极性。最大周围温度：75 °C (仅UL)。

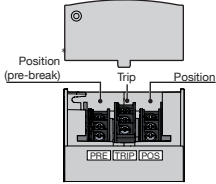
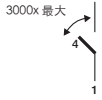
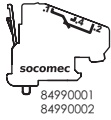

\* 预断开仅适用于手动操作

铜缆横截面 - 75 °C或以上
Ith = 10A
柔性、带电磁组件 (仅IEC)
最小 1x 0.5 mm <sup>2</sup> / 2x 1.5 mm <sup>2</sup>
绞合/实芯 (IEC / UL)
AWG 最小 1x 20 / 2x 14
AWG 最大 1x 14 / 2x 14
最小 1x 0.5 mm <sup>2</sup> / 2x 1.5 mm <sup>2</sup>
最大 1x 2.5 mm <sup>2</sup> / 2x 2.5 mm <sup>2</sup>
0.31in / 8mm
平面 5 - PZ2 - 7.08 lb.in / 0.8 Nm

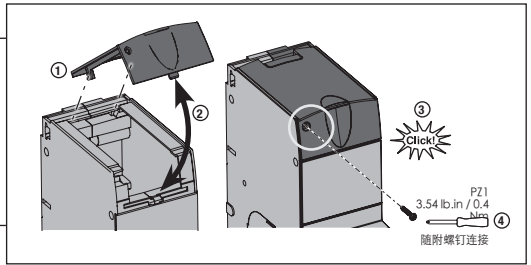
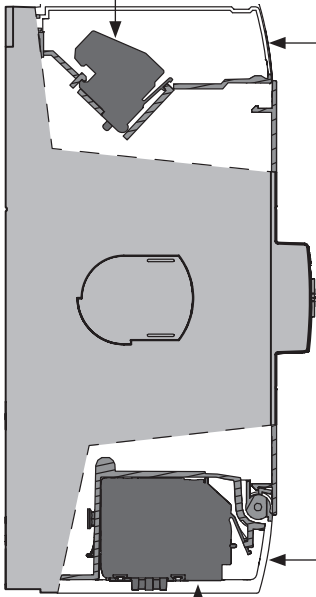
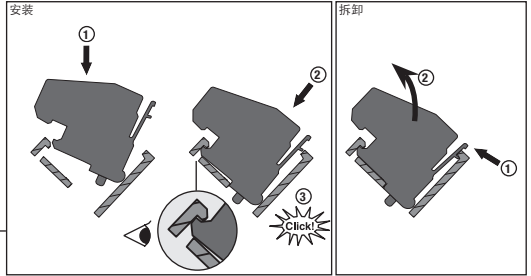

## 安装脱扣线圈

产品编号	
1 84997xxx	分励脱扣线圈
2 84998xxx	欠压脱扣线圈

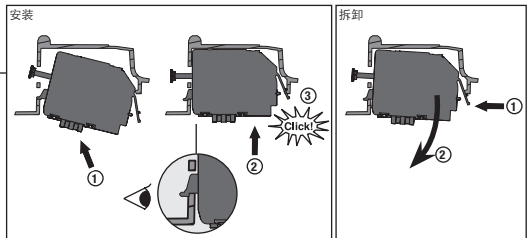

铜缆横截面
非极化线圈，可进行所有的接线。
柔性、带电磁组件 (仅IEC)
最小 0.25 mm <sup>2</sup>
最大 1.5 mm <sup>2</sup>
绞合/实芯 (IEC / UL)
AWG 最小 26
AWG 最大 14
最小 0.14 mm <sup>2</sup> - 最大 2.5 mm <sup>2</sup>
0.31in / 8mm

分励脱扣线圈必须不能永久接通电源，最大供电时间 = 2sec / min。  
避免永久供电的例子包括将辅助触点与分励脱扣线圈串联，或从载侧获取线圈电源电压，或电子限制电源电压/电流的持续时间。  
对于额定高于70VDC的直流分励脱扣线圈，应使用柜外继电器来断开线圈。

## 安装直接操作手柄

	产品编码	颜色
①	849950x2 (1)	黑色
②	849950x3 (1)	红色
③		红色

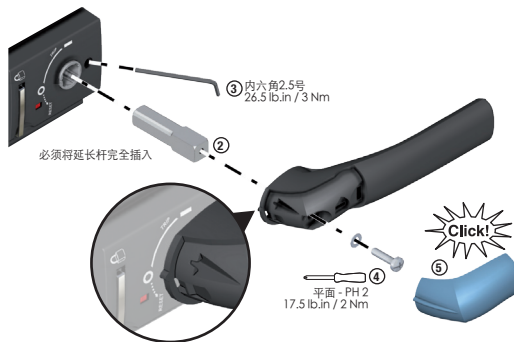
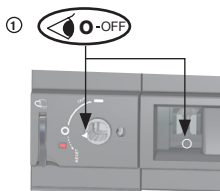

## 拆除护盖

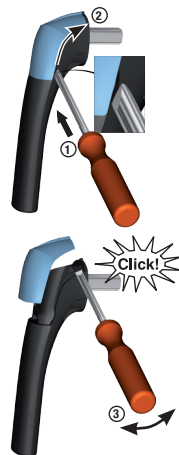

## 柜外操作手柄

	产品编号	颜色
① ② ③	74212118 (1)	黑色
	74A12118 (1)	
	742F2118	
	74AF2118	
	742G2118	红色
	74AG2118	
	742D2118	黑色
	74AD2118	
	742E2118	
	74AE2118	红色

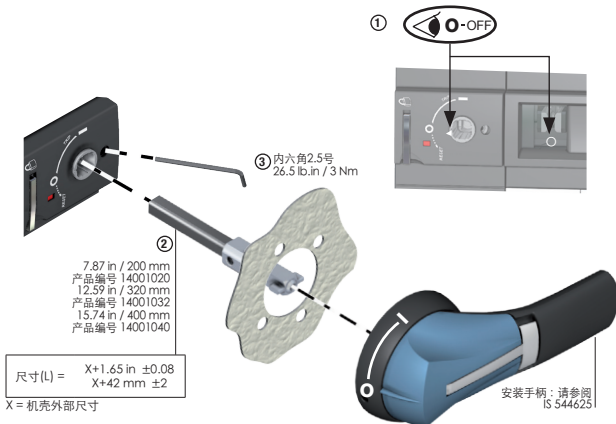
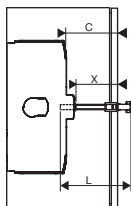

## 将挂锁安装在手柄或产品上

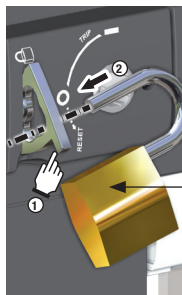

最小: 1x Ø 0.16 in / Ø 4 mm  
最大: 2x Ø 0.24 in / Ø 6 mm  
1x Ø 0.31 in / Ø 8 mm

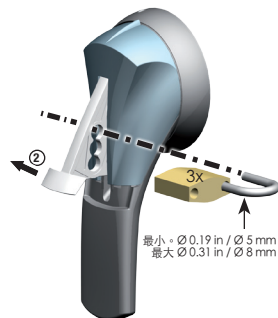









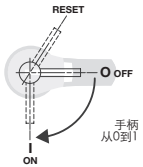
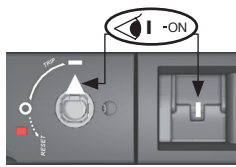

接通电源前，验证产品及其安装。

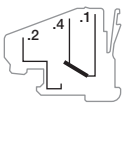
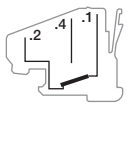
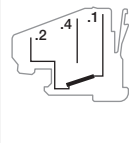
**ZH** 本设备必须由具备专业资质的人员进行安装与检修。

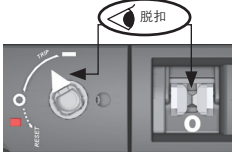
**⚠** 安装产品或其附件之一后，验证产品的操作可确保安全调试，以及防止故障或组装错误。

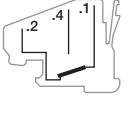
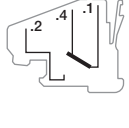
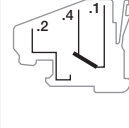
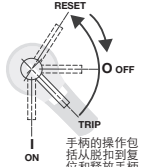
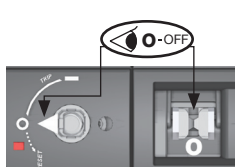
### 1) 机械检查

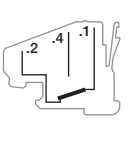
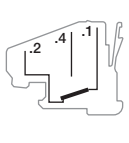
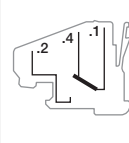
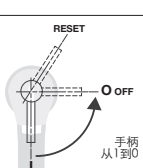
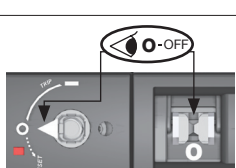
必须手动操作产品，应验证产品和辅助触点上产品的不同位置：手柄/延长杆的位置；电源触点和辅助触点的位置。  
执行的操作包括：闭合1次，打开1次，闭合1次，脱扣1次（按脱扣按钮的操作）和复位1次。

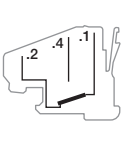
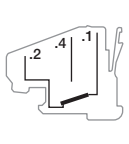
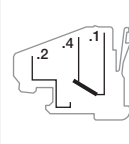
需执行的操作	产品的最终状态	辅助触点状态			产品上的挂锁功能	
		PRE (预断开)	TRIP (脱扣位置)	POS (出头合闸位置)		
 <p>手柄从0到1</p>	 <p>ON</p>					常开
 <p>按脱扣按钮的操作</p>	 <p>脱扣</p>					常开
 <p>手柄的操作包括从脱扣到复位和释放手柄</p>	 <p>OFF</p>					可能
 <p>手柄从1到0</p>	 <p>OFF</p>					可能

### 2) 电气检查

除了机械检查外，应通过使用线圈（由正确电压供电）测试脱扣功能，来执行产品的电气操作。

分励脱扣线圈必须不能永久接通电源，最大供电时间 = 2 sec。

### 3) 定期检查

执行安装操作过程中或长时间关机后，建议进行维护并包括上述机械和电气检查（建议维护频率：每年1次）。

可能会随时更改，恕不另行通知。

CORPORATE HQ CONTACT: SOCOMEC SAS, 1-4 RUE DE WESTHOUSE, 67235 BENFELD, FRANCE